

# Manیتowoc 11000-1

## Product Guide

ASME B30.5

Metric / Imperial



### Features

- 100 t (110 USt) capacity
- 61,0 m (200 ft) heavy-lift boom
- Max boom + jib combination:  
57,9 m (190 ft) + 18,3 m (60 ft)
- 213 kW (285 HP) engine
- 163 m/min (535 fpm) maximum line speed
- 113 kN (25,200 lb) rated line pull



# Contents

Specifications	4
Outline dimensions	7
Winch performance data	13
Load chart notes	14
Boom combinations	15
Heavy-lift boom range / charts	16
Fixed jib boom range / load charts	18
Clamshell	21
Manitowoc Crane Care	22

# Specifications

## Upperworks



### Engine

HINO J08E-UV, 6 cylinder, water-cooled diesel, direct fuel injection with turbocharger, 213 kW (285 HP) at 2100 high-idle RPM. Maximum torque 1017 N•m (750 lb•ft) net at 1,600 rpm; Interim Tier 4/ Stage IIIB (Required for sale in the US/Canada/ Europe; requires "Ultra Low Sulfur Diesel")

HINO J08E-VM, 6 cylinder, water-cooled diesel, direct fuel injection with turbocharger, 213 kW (285 HP) at 2100 high-idle RPM. Maximum torque 1017 N•m (750 lb•ft) net at 1,600 rpm; Tier 3 (Required for sale outside the US/Canada/Europe)

One diesel fuel tank, 400 liters (105 gallons) capacity.

Two 12 volt 136 AH capacity batteries, 24 volt system and 90 amp alternator.

All wiring harnesses and connectors are numbered for easier servicing. Machine is equipped with individual fused branch circuits.



### Controls

Full-flow hydraulic control system for constant variable pressure to front and rear drums, boom hoist brakes and clutches. Controls respond instantly to the touch, delivering smooth function operation.



### Hydraulic system

All three variable displacement piston-type pumps are driven by a heavy-duty pump drive. One of these pumps is used in the left propel circuit and hook hoist circuit, and can accommodate an optional third circuit. Another is used in the right propel circuit, boom hoist circuit and hook hoist circuit. The third variable displacement pump is used in the swing circuit. In addition, two gear pumps are used in the control system and auxiliary equipment, and two gear pumps serve the brake cooling system.

**Maximum pressure rating** . . . . .31.9 MPa (4,630 psi)

**Load hoist, boom hoist and propel** . .2 Piston pumps  
**Swing** . . . . .1 Piston pump  
**Control system and auxiliary** . . . . .2 Gear pumps  
**Brake cooling system** . . . . .2 Gear pumps

**Reservoir capacity:** . . . . .440 liter (116 US gallon)

**Cooling:** . . . . .oil-to-air heat exchanger

**Filtration:** full-flow and bypass type with replaceable paper elements.



### Drums

Front and rear drums for load hoist powered by variable displacement piston-type motors, driven through planetary reducers. Powered hoisting/ lowering and free-fall operation is standard. Drum turn indicators for front and rear drums are also standard.

**Drums:** (front and rear) 614 mm (24.2") P.C.D. x 617 mm (24.3") wide drums, grooved for 26.0 mm wire rope.

**Brakes:** Counterbalance valve and spring set hydraulically released multiple disk brake mounted on hoist motor. External ratchet is fitted for locking drum.

#### Wire rope capacity:

Front drum . . . . .235 m (771 ft) working length  
Rear drum . . . . .160 m (525 ft) working length

**Line speed:** Single line on the first drum layer

**Hoisting:** . . . . .120m/min (390 ft/min)

**Lowering:** . . . . .120m/min (390 ft/min)

➤ **Optional third drum:** grooved for 22 mm wire rope; free-fall is optional.  
Wire rope working length . . . . . 145m (476').



### Swing system

**Swing unit:** Powered by a hydraulic piston-type motor driving spur gears through planetary reducers, the swing system provides 360° rotation.

**Swing brake:** A spring-set, hydraulically released multiple-disc brake is mounted on swing motor.

**Swing lock:** 4-Position lock for transportation.

**Rotating bed turntable:** Single-row ball bearing with an integral internally cut swing gear.

**Swing speed:** 4.0 rpm



### Boom support system

Single drum powered by a hydraulic axial piston motor through a planetary reducer.

**Brake:** A spring-set, hydraulically released multiple-disc brake is mounted on the boom hoist motor. An external ratchet is fitted for locking the drum.

**Drum:** Single drum, grooved for 16 mm diameter wire rope. Boom hoist reeving is 12-part line.

#### Wire Rope Capacity:

Drum 150 m (492 ft) working length.

# Specifications

**Line speed:** Single line on first drum layer.

**Hoisting** ..... 70m/min (230 ft/min)

**Lowering** ..... 70m/min (230 ft/min)



## Gantry

This high folding type gantry is fitted with a sheave frame for boom hoist reeving. It provides full up, full down positions.



## Counterweight

Upper weight (5 pieces): 31,300 kg (69,000 kg)  
Carbody weight (2 pieces): 14,400 kg (31,750 lb)



## Operator's cab

Totally enclosed, full vision cab fitted with tinted safety glass and opening front window. A fully adjustable, highbacked seat with arm rests. Short handle control levers; electronic twist grip hand throttle. An air conditioner, a signal horn and windshield wiper are standard.

### Lights:

2 - Front flood lights

1 - Cab inside light

### Safety device

New easy to read at a glance LMI and maintenance display.

## Lowerworks



## Carbody

The durable carbody features steel welded construction with extendible axles.



## Crawlers

Crawler assemblies can be hydraulically extended for wide-track operation or retracted for transportation.

Crawler belt tension adjusted with hydraulic jack and maintained by shims between idler block and frame.

The independent hydraulic propel drive is built into each crawler side frame. Each drive consists of a hydraulic motor propelling a driving tumber through a planetary gearbox. Hydraulic motor and gear box are built into the crawler side frame within the shoe

width. The track rollers are sealed for maintenance-free operation.

**Crawler brakes:** multiple disk type, spring set hydraulically released parking brakes are built into each propel drive.

### Crawler shoes

914 mm (36") wide crawler.

### Travel speed

(High/Low) 1.73/1.2 km/h (1.07/0.71 mph)

## Attachments



## Boom

Welded lattice construction using tubular, high-tensile steel chords with pin connections between sections.

Two idler sheaves and three point sheaves are standard.

Basic boom length 12,2 m (40'). Basic boom consists of the boom butt 5,8 m (19') and boom top 6,39 m (21').

Optional boom inserts are welded lattice construction with tubular, high-tensile steel chords and pin connections on each one of 3,0 m (10'), 6,1 m (20') and 12,2 m (40') inserts.

Maximum total length of boom 61,0 m (200').



## Fixed jib

The optional fixed jib employs welded lattice construction with tubular, high-tensile steel chords with pin connections between sections.

Basic jib length 9,14 m (30'). Basic jib length consists of jib butt section 4,57 m (15') and jib top 4,57 m (15').

Optional jib boom inserts of 3,0 m (10'), 6,1 m (20') are available for extension capabilities up to 18 m (60').

Maximum total length of boom and jib 57,9 m (190') + 18 m (60') is 76,2 m (250').

## Tool and accessories

A set of tools and accessories are furnished.

## Optional Equipment

➤ Optional: Blocks and hooks each with roller bearing sheaves grooved for 26.0 mm diameter wire rope, and roller bearing swivel with hook latch.

# Specifications

- 11.3 t swivel hook and weight ball, 460 kg (15 USt ball hook, 1,310 lb wedge socket for 26 mm wire rope.)
- 35 t hook block, 700 kg with one 617 mm Nominal O.D. roller bearing sheave. (40 USt hook block, 2,311 lb with three 24" Nominal O.D. roller bearing sheaves.)
- 70 t hook block, 900 kg, three 617 mm Nominal O.D. roller bearing bearing sheaves. (75 USt hook block, 3,820 lb, with four 24" Nominal O.D. roller bearing sheaves.)
- 90 t hook block, 1 300 kg, with four 617 mm Nominal O.D. roller bearing sheaves. (110 USt hook block, 2,946 lb with four 24" Nominal O.D. roller bearing sheaves.)
- Optional: Detachable upper boom point with one 575 mm Nominal outer diameter roller bearing steel sheave grooved for 26mm rope for liftcrane.
- Machine inclination sensor.
- Swing angle detection and angle limiter.
- Counterweight detection.
- Hydraulic tagline.
- External lamp for overload alarm.

## Working weight

Approximately 90,000 kg (198,500 lb) including upperworks and lowerworks, full upper counterweights, full carbody counterweights, and 12,2 m (40') basic boom.

## Ground pressure

Approximately 88.8 kPa (12.9 psi) with basic boom and no load.

## Gradeability

With basic boom: 40%.

# Specifications

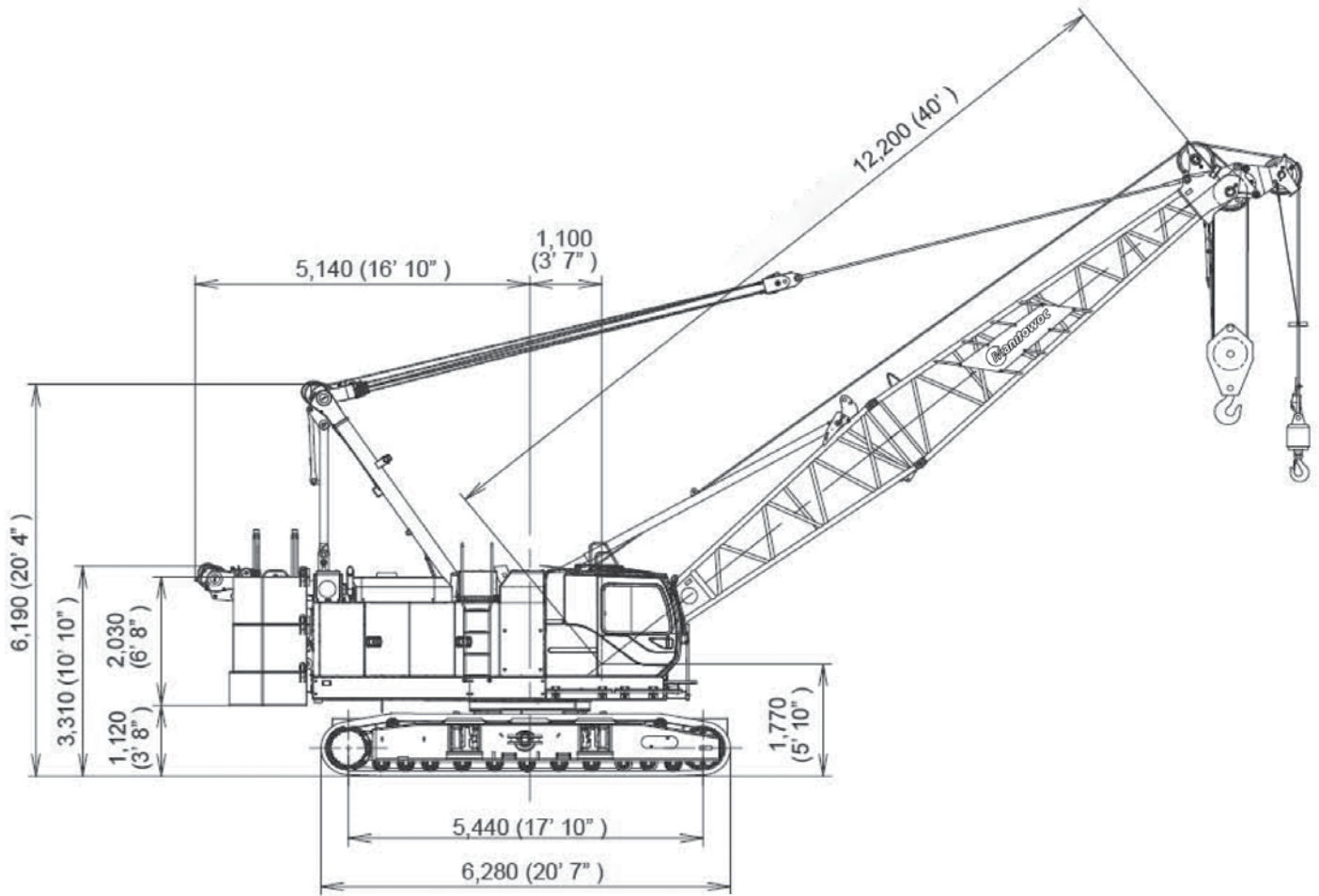

# Outline dimensions

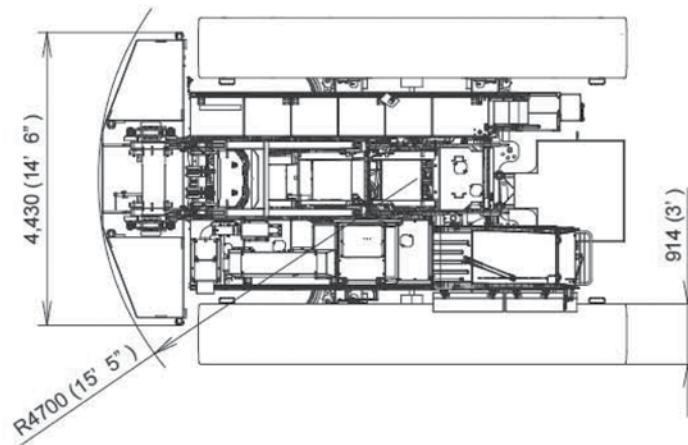
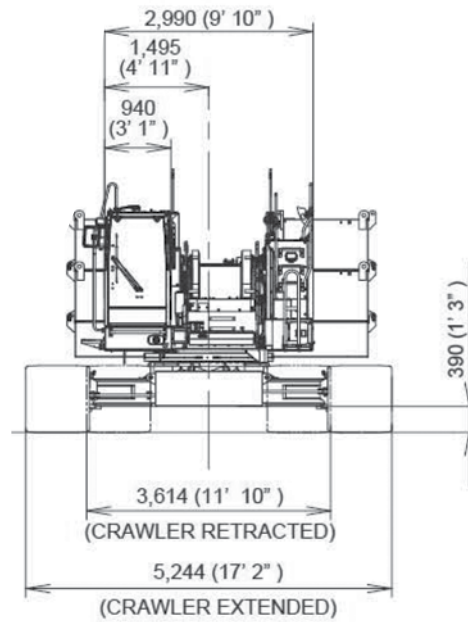

# Outline dimensions

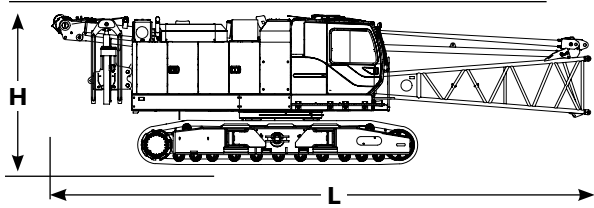

Upperworks		x 1
Length	12,09 m	39' 8"
Width	3,61 m	11' 10"
Height	3,32 m	10' 11"
Weight	43 150 kg	95,128 lb

*Note: Weight includes base machine, crawler, gantry, maximum hoist and whip lines on drums, boom butt, full hydraulic fluid reservoir, and one third tank of fuel.*

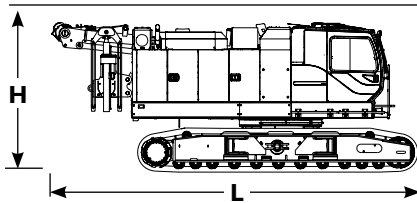

Upperworks		x 1
Length	8,21 m	26' 11"
Width	3,61 m	11' 10"
Height	3,32 m	10' 11"
Weight	41 090 kg	90,586 lb

*Note: Weight includes base machine, crawler, gantry, maximum hoist and whip lines on drums, full hydraulic fluid reservoir, and one third tank of fuel.*

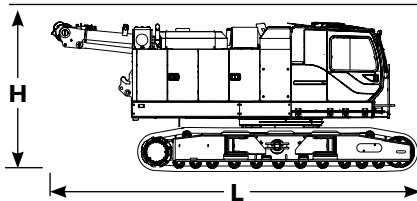

Upperworks		x 1
Length	8,21 m	26' 11"
Width	3,61 m	11' 10"
Height	3,32 m	10' 11"
Weight	40 220 kg	88,668 lb

*Note: Weight includes base machine, crawler, gantry, maximum hoist and whip lines on drums without self-removal unit, full hydraulic fluid reservoir, and one third tank of fuel.*

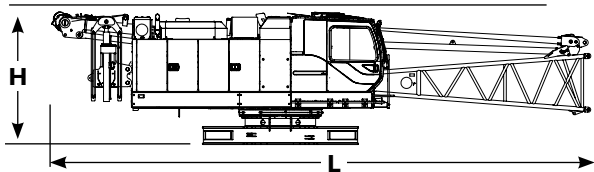

Upperworks without crawlers		x 1
Length	12,09 m	39' 8"
Width	2,99 m	9' 10"
Height	2,93 m	9' 8"
Weight	27 870 kg	61,442 lb

*Note: Weight includes base machine, gantry, maximum hoist and whip lines on drums, boom butt, full hydraulic fluid reservoir, and one third tank of fuel.*

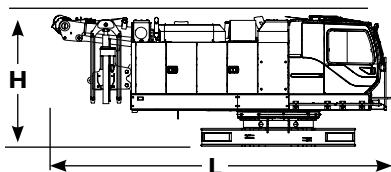

Upperworks without crawlers		x 1
Length	7,70 m	25' 3"
Width	2,99 m	9' 10"
Height	2,93 m	9' 8"
Weight	25 810 kg	56,900 lb

*Note: Weight includes base machine, gantry, maximum hoist and whip lines on drums, full hydraulic fluid reservoir, and one third tank of fuel.*

▶ Option

# Outline dimensions

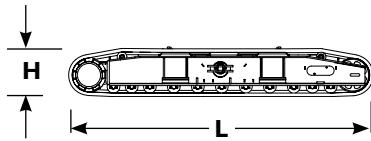

Crawlers		x 2
Length	6,28 m	20' 7"
Width	0,91 m	3' 0"
Height	0,98 m	3' 3"
Weight	7 640 kg	16,843 lb

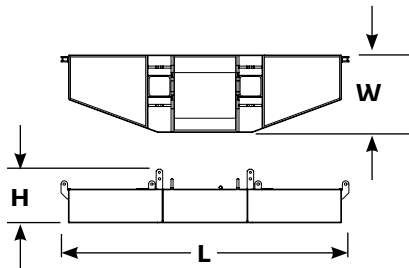

Upper counterweight		x 1
Length	4,43 m	14' 6"
Width	1,19 m	3' 11"
Height	0,83 m	2' 9"
Weight	8 310 kg	18,320 lb

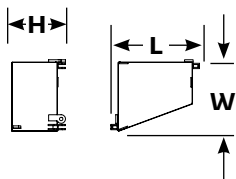

Upper counterweight (R)		x 2
Length	1,45 m	4' 9"
Width	1,17 m	3' 10"
Height	0,88 m	2' 11"
Weight	5 750 kg	12,677 lb

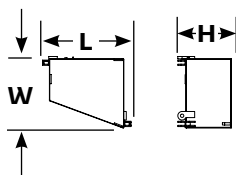

Upper counterweight (L)		x 2
Length	1,45 m	4' 9"
Width	1,17 m	3' 10"
Height	0,88 m	2' 11"
Weight	5 750 kg	12,677 lb

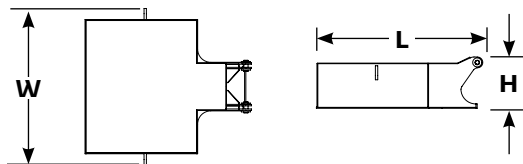

Carbody counterweight		x 2
Length	1,90 m	6' 3"
Width	1,79 m	5' 10"
Height	0,59 m	1' 11"
Weight	7 200 kg	15,873 lb

# Outline dimensions

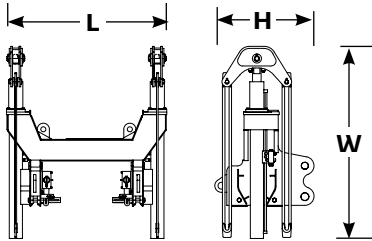

Self removal unit		x 1
Length	1,59 m	5' 3"
Width	1,90 m	6' 3"
Height	0,98 m	3' 3"
Weight	870 kg	1,918 lb

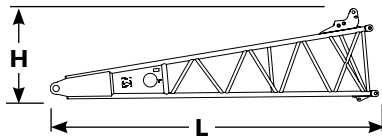

Boom butt 5,8 m (19')		x 1
Length	5,97 m	19' 7"
Width	1,49 m	4' 11"
Height	1,70 m	5' 7"
Weight	1 475 kg	3,252 lb

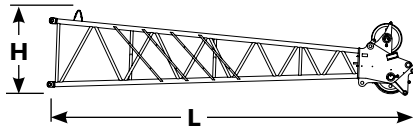

Boom top 6,4 m (21')		x 1
Length	6,91 m	22' 8"
Width	1,50 m	4' 11"
Height	1,31 m	4' 4"
Weight	1 170 kg	2,580 lb

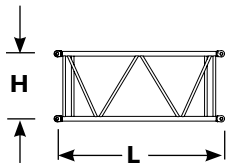

Boom insert 3,0 m (10')		x 1,2
Length	3,16 m	10' 4"
Width	1,49 m	4' 11"
Height	1,31 m	4' 4"
Weight	310 kg	685 lb

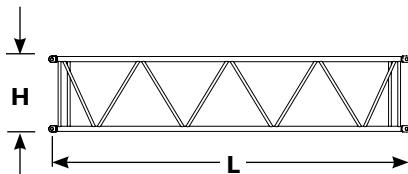

Boom insert 6,10 m (20')		x 1,2
Length	6,21 m	20' 5"
Width	1,49 m	4' 11"
Height	1,31 m	4' 4"
Weight	520 kg	1,145 lb

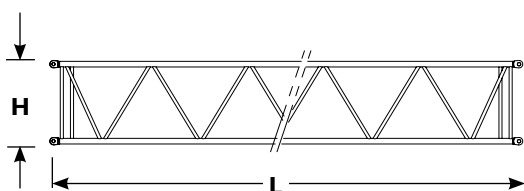

Boom insert 12,2 m (40')		x 1,2,3
Length	12,31 m	40' 5"
Width	1,49 m	4' 11"
Height	1,31 m	4' 4"
Weight	960 kg	2,115 lb

Note: Use one "A" type insert with lug required for any boom combinations that require a 12,2 m (40') insert.

Option

# Outline dimensions

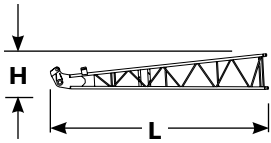

Fixed jib butt			x 1
Length	4,81 m	15' 9"	
Width	0,80 m	2' 8"	
Height	0,80 m	2' 8"	
Weight	200 kg	440 lb	

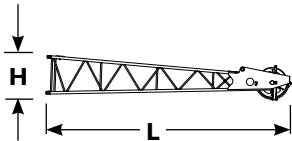

Fixed jib top			x 1
Length	5,00 m	16' 5"	
Width	0,79 m	2' 7"	
Height	0,80 m	2' 8"	
Weight	280 kg	617 lb	

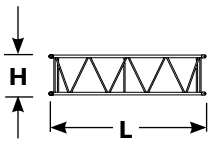

Fixed jib insert 3,0 (10')			x 1
Length	3,11 m	10' 2"	
Width	0,80 m	2' 8"	
Height	0,80 m	2' 8"	
Weight	100 kg	220 lb	

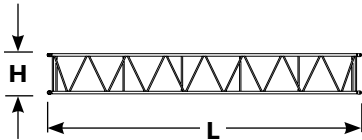

Fixed jib insert 6,1 m (20')			x 1
Length	6,16 m	20' 3"	
Width	0,80 m	2' 8"	
Height	0,80 m	2' 8"	
Weight	180 kg	395 lb	

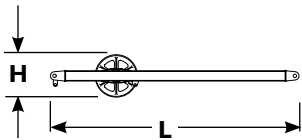

Fixed jib strut			x 1
Length	3,62 m	11' 11"	
Width	0,84 m	2' 9"	
Height	0,62 m	2' 0"	
Weight	250 kg	550 lb	

# Winch performance data

Line pull		
	Rated line pull kg (lb)	*Maximum line pull kg (lb)
Front drum	11 420 (25,200)	21,200 (46,800)
Rear drum	11 420 (25,200)	21,200 (46,800)
Optional 3rd drum	7700 (17,700)	15,600 (34,400)

\* Maximum line pull is not based on wire rope strength.

Wire rope specifications				
Use	Specs	Diameter mm	Working length m (ft)	Breaking strength kg (lb)
Front drum	IWRC C/O 6 X Fi (29)	26,0	235 (771)	54 430 (120,000)
Rear drum	IWRC C/O 6 X Fi (29)	26,0	160 (525)	54 430 (120,000)
Boom hoist drum	IWRC C/O 6 X Fi (31)	16,0	150 (492)	21 410 (47,200)
Optional 3rd drum	IWRC C/O 6 X Fi (29)	22,0	145 (476)	37 000 (81,600)

Front and rear winch						
Layer		Line speed m/min (ft/min)				
		1	2	3	4	5
Rated line pull	Single line pull kg (lb)					
	0 (0)	125 (410)	133 (436)	142 (466)	151 (495)	160 (525)
	2 268 (5,000)	124 (406)	132 (434)	141 (463)	150 (492)	159 (522)
	4 536 (10,000)	108 (355)	108 (355)	108 (355)	108 (355)	108 (355)
	6 804 (15,000)	72 (237)	72 (237)	72 (237)	72 (237)	72 (237)
	9 072 (20,000)	54 (177)	54 (177)	54 (177)	54 (177)	54 (177)
	11 340 (25,000)	43 (142)	43 (142)	43 (142)	43 (142)	43 (142)
	13 608 (30,000)	36 (118)	36 (118)	36 (119)	38 (126)	41 (133)
	15 876 (35,000)	32 (104)	34 (111)	36 (118)	38 (125)	–
	18 144 (40,000)	32 (104)	34 (111)	–	–	–

NOTE: Line speeds and line pull based on single line.  
Line pulls are not based on wire rope strength.

# Load chart notes

- Rated loads included in the charts are the maximum allowable freely suspended loads at a given boom length, boom angle and load radius, and have been determined for the machine standing level on firm supporting surface under ideal operating conditions. The user must limit or de-rate rated loads to allow for adverse conditions (such as soft or uneven ground, out-of-level conditions, wind side loads, pendulum action, jerking or sudden stopping of loads, inexperience of personnel, multiple machine lifts, and traveling with a load).
- Capacities do not exceed 75% of minimum tipping loads. Capacities based on factors other than machine stability such as structural competence are shown by asterisk \* in the charts located in the operator's crane cab.
- The machine must be reeved and set-up as stated in the operation manual and all the instruction manuals. If these manuals are missing, obtain replacements. Boom backstops are required for all boom lengths. Gantry must be in the fully raised position for all operations. Crawlers must be fully extended and be locked in position. The crane must be leveled to within 1% on a firm supporting surface.
- Do not attempt to lift where no radius or load is listed as crane may tip or collapse.
- Attempting to lift more than rated loads may cause machine to tip or collapse. Do not tip machine to determine capacity.
- Weight of hooks, hook blocks, slings and other lifting devices are a part of the total load. Their total weight must be subtracted from the rated load to obtain the weight that can be lifted.
- When lifting over boom point with jib or upper boom point installed, rated loads for the boom must be deducted as shown below.

jib length m (ft)	Upper boom point	9,1 (30)	12,2 (40)	15,2 (50)	18,3 (60)
Deduct kg (lb)	200 (420)	1200 (2,500)	1700 (3,700)	2400 (5,100)	3100 (6,700)

- The total load that can be lifted by the fixed jib is limited by rated jib loads. The total load that can be lifted with the upper boom point is limited by rated upper boom point loads.

- Boom lengths for fixed jib mounting are 24,4 m (80 ft) to 57,9 m (190 ft).
- The total load that can be lifted by the upper boom point is: the rated load for the boom (without upper boom point installed) minus 200 kg (420 lb); however, the upper boom point rated load should not exceed 10 800 kg (24,000 lb).
- An upper boom point cannot be used on a 61 m (200 ft) boom length.
- The boom should be erected over the front of the crawlers, not laterally. When erecting and lowering the boom with a length of 57,9 m (190 ft) with jib, blocking must be placed at the end of the crawlers. See operator's manual for details.
- Least stable position is over the side.
- Maximum hoist load for number of reeving parts of line for hoist rope.

#### Maximum load for main boom

No. of parts of line	1	2	3	4	5
Maximum loads kg (lb)	11 420 (25,200)	22 861 (50,400)	34 292 (75,600)	45 722 (100,800)	57 153 (126,000)

No. of parts of line	6	7	8
Maximum loads kg (lb)	68 583 (151,200)	80 014 (176,400)	100 000 (220,000)

#### Maximum load for fixed jib

No. of parts of line	1
Maximum loads kg (lb)	10 800 (24,000)

#### Maximum load for upper boom point

No. of parts of line	1
Maximum loads kg (lb)	10 800 (24,000)

- Lifting capacities listed apply only to the machine as originally manufactured for and supplied by Manitowoc Cranes, Inc. Modifications to this machine or use of equipment other than that specified can reduce operating capacity.
- Designed and rated to comply with ASME Code B30.5.

Operation of this equipment in excess of rated loads or disregard of instruction voids the warranty.

# Boom combinations

## No. 11000-1 heavy-lift boom combinations

Boom length m (ft)	Boom inserts		
	3,1 m (10 ft)	6,1 m (20 ft)	12,2 m (40 ft)
12,2 (40)	–	–	–
15,2 (50)	1	–	–
18,3 (60)	2	–	–
21,3 (70)	1	1	–
24,4 (80)	2	1	–
27,4 (90)	1	2	–
30,5 (100)	2	2	–
33,5 (110)	1	1	1*
36,6 (120)	2	1	1*
39,6 (130)	1	2	1*
42,7 (140)	2	2	1*
45,7 (150)	1	1	2*
48,8 (160)	2	1	2*
51,8 (170)	1	2	2*
54,9 (180)	2	2	2*
57,9 (190)	1	1	3*
61,0 (200)	2	1	3*

\* NOTE: One 40 ft (12,20 m) boom insert with lug 40A is required for fixed jib. When no jib is installed a 40 ft (12,20 m) boom can be used instead of 40A.

## No. 11000-1 fixed jib combinations

Fixed jib length m (ft)	Fixed jib inserts	
	3,1 m (10 ft)	6,1 m (20 ft)
9,1 (30)	–	–
12,2 (40)	1	–
15,2 (50)	–	1
18,3 (60)	1	1

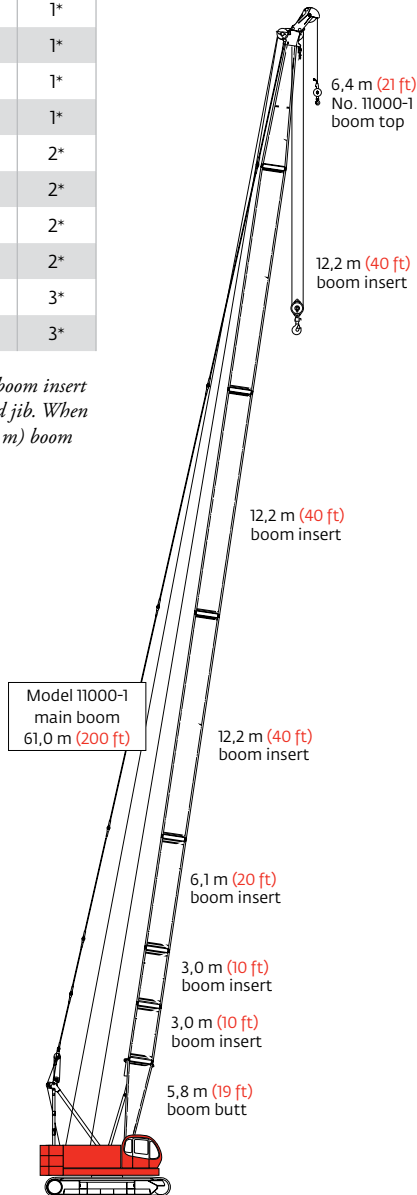

**Model 11000-1  
Main boom 61,0 m (200 ft)**

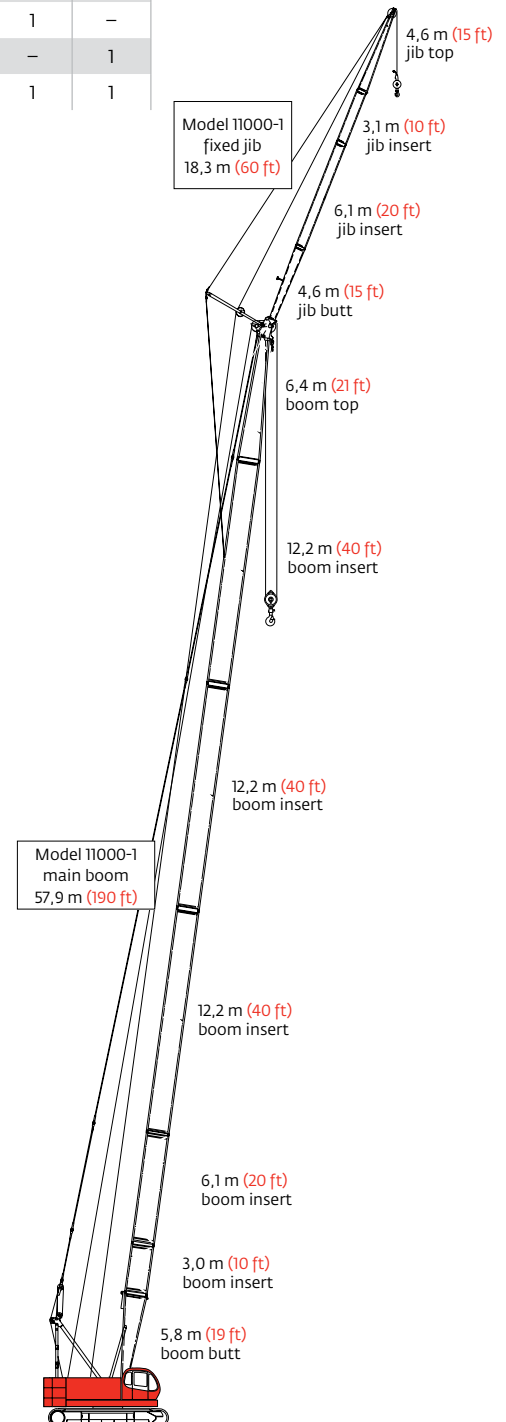

**Model 11000-1  
Fixed jib on main boom  
76,2 m (250 ft)**

# Heavy-lift boom range diagram

No. 11000-1 main boom

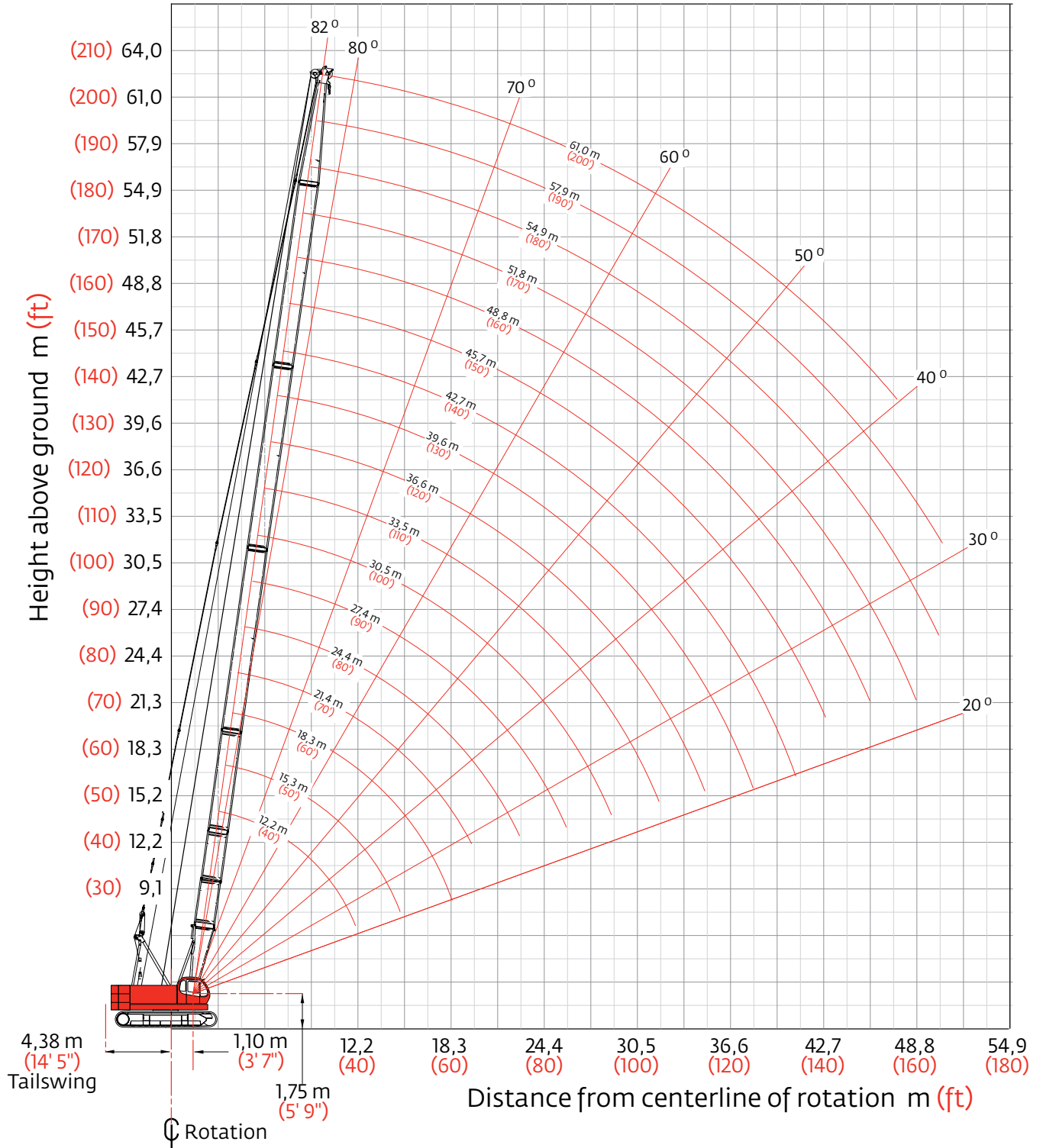

# Heavy-lift boom load charts

## Model 11000-1 liftcrane boom capacities – 11000-1 main boom

31,3 t (69,000 lb) upper counterweight + 14,4 t (31,750 lb) carbody counterweight

360° Rating

kg (lb) x1 000

Boom m (ft)	12,2 (40)	15,2 (50)	18,3 (60)	21,3 (70)	24,4 (80)	27,4 (90)	30,5 (100)	33,5 (110)	36,6 (120)	39,6 (130)	42,7 (140)	45,7 (150)	48,8 (160)	51,8 (170)	54,9 (180)	57,9 (190)	61,0 (200)
Radius																	
3,3 (11)	100,0* (220.0*)																
3,5 (12)	98,3* (213.3*)	96,7* (213.2*)	90,9* (-)														
4,0 (14)	90,3* (188.1*)	90,2* (187.8*)	90,1* (187.4*)														
4,5 (16)	81,0* (165.5*)	80,9* (165.3*)	80,7* (164.8*)	68,4* (151.0*)	- (151.0*)												
5,5 (18)	66,8* (147.8*)	66,7* (147.4*)	66,4* (146.9*)	66,4* (146.7*)	66,3* (146.5*)	57,0* (125.8*)	56,9* (123.6*)										
6,0 (20)	61,3* (132.8)	61,1* (132.4)	61,0* (132.2)	61,0* (132.2)	60,8* (131.8)	56,5* (124.0)	56,3* (100.6)	45,7* (100.8*)									
7,0 (24)	49,3 (101.3)	49,1 (101.0)	49,0 (100.8)	49,2 (101.3)	49,1 (101.0)	48,4* (100.8)	48,3* (80.2)	44,7* (96.5*)	43,7* (94.2*)	38,6* (85.1*)	33,0* (72.9*)						
8,0 (28)	40,1 (80.9)	40,0 (80.7)	39,9 (80.5)	40,1 (80.8)	39,9 (80.5)	39,9 (80.5)	39,8 (61.3)	39,6* (80.2)	39,4* (79.9)	37,7* (78.2*)	32,5* (70.8*)	28,1* (61.3*)	- (50.2*)				
10,0 (34)	29,4 (61.7)	29,4 (62.0)	29,2 (61.6)	29,4 (62.0)	29,2 (61.6)	29,2 (61.6)	29,1 (48.9)	29,1 (61.3)	29,0 (61.1)	28,9 (60.9)	28,5* (60.5)	26,5* (57.2*)	22,4* (49.2*)	19,7* (43.2*)	17,4* (38.2*)	15,4* (33.8*)	13,7* (30.3*)
12,0 (40)	21,6* (45.9*)	23,1 (49.8)	22,9 (49.3)	23,1 (49.8)	22,9 (49.3)	22,9 (49.3)	22,7 (43.4)	22,7 (48.9)	22,6 (48.7)	22,5 (48.4)	22,4 (48.2)	22,2* (48.0)	21,3* (46.6*)	18,7* (41.2*)	16,5* (36.4*)	14,6* (32.2*)	13,0* (28.7*)
14,0 (44)		18,8 (44.3)	18,7 (43.8)	18,9 (44.1)	18,7 (43.8)	18,7 (43.7)	18,5 (32.3)	18,5 (43.4)	18,4 (43.0)	18,3 (42.8)	18,2 (42.6)	18,1 (42.4)	18,1* (42.1*)	17,6* (40.0*)	15,6* (35.1*)	13,8* (31.1*)	12,3* (27.7*)
16,0 (55)			15,9 (32.9)	16,0 (33.2)	15,8 (32.7)	15,7 (32.5)	15,6 (21.4)	15,6 (32.3)	15,4 (32.0)	15,3 (31.6)	15,2 (31.4)	15,1 (31.2)	15,2 (31.4)	15,1* (31.2)	14,5* (30.8*)	13,0* (28.1*)	11,6* (24.9*)
22,0 (75)					10,5 (22.1)	10,4 (21.8)	10,2 (15.8)	10,2 (21.4)	10,1 (21.2)	9,9 (20.9)	9,8 (20.5)	9,7 (20.3)	9,8 (20.5)	9,7 (20.3)	9,5 (19.9)	9,5 (19.9)	8,7* (18.5*)
28,0 (95)							7,4 (-)	7,4 (15.6)	7,2 (15.3)	7,1 (15.0)	6,9 (14.6)	6,9 (14.4)	6,9 (14.5)	6,7 (14.3)	6,6 (14.0)	6,6 (13.9)	6,4 (13.5)
32,0 (110)								6,2 (-)	6,0 (12.6)	5,8 (12.1)	5,7 (11.9)	5,6 (11.7)	5,7 (11.7)	5,6 (11.5)	5,4 (11.1)	5,3 (11.0)	5,2 (10.6)
36,0 (120)										5,0 (10.8)	4,8 (10.3)	4,7 (10.3)	4,7 (10.1)	4,5 (9.8)	4,4 (9.6)	4,4 (9.4)	4,2 (9.2)
38,0 (130)										4,6 (-)	4,4 (9.2)	4,3 (8.9)	4,3 (8.9)	4,1 (8.7)	4,1 (8.5)	4,0 (8.2)	3,8 (7.8)
40,0 (140)											4,1 (-)	3,9 (8.0)	3,9 (7.9)	3,8 (7.7)	3,7 (7.4)	3,6 (7.2)	3,4 (6.5)
44,0 (150)													3,4 (7.1)	3,2 (6.8)	3,1 (6.5)	3,0 (6.3)	2,6* (5.2)
48,0 (160)														2,7 (5.9)	2,6 (5.6)	2,5 (5.3)	
52,0 (165)															2,3 (5.1)	2,1 (4.6)	

\*Rated loads based on factors other than machine stability such as structural competence.

Meets ASME B30.5 Requirements – Capacities do not exceed 75% of static tipping load.

NOTICE: This capacity chart is for reference only and must not be used for lifting purposes.

For complete chart, refer to [www.cranelibrary.com](http://www.cranelibrary.com).

Meets ASME B30.5 Requirements - Capacities do not exceed 75% of static tipping load.  
NOTICE: This capacity chart is for reference only and must not be used for lifting purposes.

# Fixed jib range diagram

No. 11000-1 fixed jib on main boom

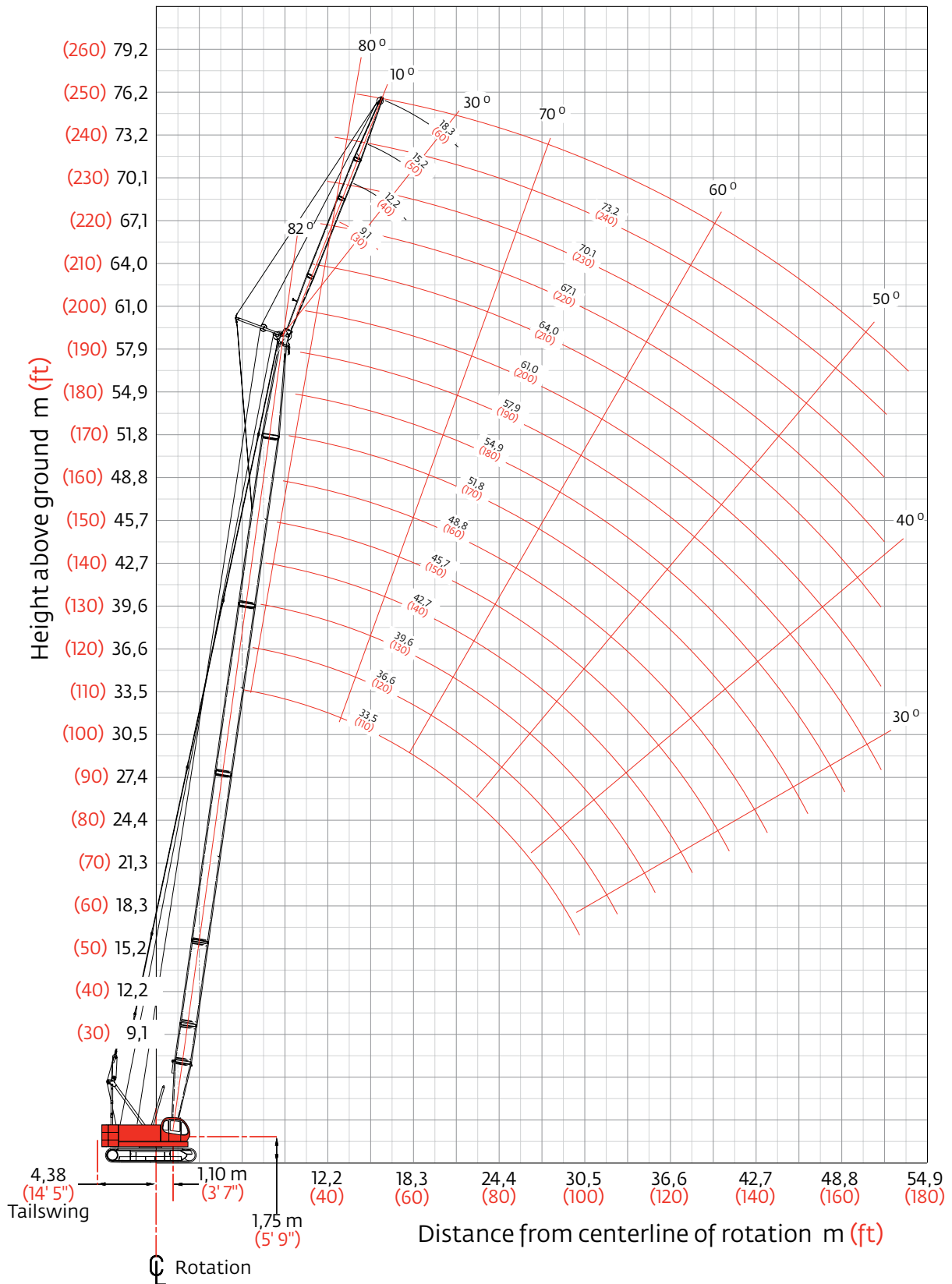

# Fixed jib load charts

## Model 11000-1 liftcrane jib capacities No. 11000-1 fixed jib on main boom

28 800 kg (63,500 lb) upper counterweight, 7 300 kg (16,100 lb) carbody counterweight crawler extended  
360° Rating kg (lb) x 1 000

		10° offset					30° offset					
		24,4 (80)	30,5 (100)	39,6 (130)	48,8 (160)	57,9 (190)	24,4 (80)	30,5 (100)	39,6 (130)	48,8 (160)	57,9 (190)	
jib 9,1 m (30 ft)	Radius											
	10,0 (30)	10,8 (24.0)					10,0 (30)					
	12,0 (40)	10,8 (24.0)	10,8 (24.0)	10,8 (24.0)			12,0 (40)	9,5 (21.0)				
	14,0 (50)	10,8 (24.0)	10,8 (24.0)	10,8 (24.0)	10,8 (24.0)	— (19.4)	14,0 (50)	9,2 (19.5)	9,4 (20.6)	— (21.0)		
	18,0 (60)	10,8 (24.0)	10,8 (24.0)	10,8 (24.0)	10,7 (23.7)	8,4 (18.6)	18,0 (60)	8,0 (17.5)	8,5 (18.6)	9,2 (20.1)	9,5 (21.0)	8,2 (18.2)
	24,0 (80)	8,0 (17.3)	7,8 (16.8)	7,4 (16.1)	7,2 (15.5)	6,9 (14.8)	24,0 (80)	6,7 (14.8)	7,3 (15.9)	7,6 (16.6)	7,4 (16.0)	7,2 (15.5)
	30,0 (100)	5,9 (12.8)	5,7 (12.2)	5,3 (11.5)	5,0 (10.9)	4,7 (10.2)	30,0 (100)		6,0 (—)	5,4 (11.8)	5,2 (11.2)	4,9 (10.6)
	36,0 (120)		4,5 (—)	3,9 (8.5)	3,7 (7.9)	3,3 (7.2)	36,0 (120)				3,8 (8.2)	3,5 (7.5)
	42,0 (140)			2,9 (6.1)	2,7 (5.8)	2,3 (4.8)	42,0 (140)					2,4 (5.2)
	44,0 (150)			2,7 (—)	2,4 (4.7)	2,0 (3.9)	44,0 (150)					2,1 (4.2)
48,0 (160)				1,7 (3.6)	1,5 (—)	48,0 (160)						
52,0 (170)				1,4 (—)		52,0 (170)						
jib 12,2 m (40 ft)	Radius											
	10,0 (30)	10,8 (—)	10,8 (—)				10,0 (30)					
	12,0 (40)	10,8 (24.0)	10,8 (24.0)	10,8 (—)			12,0 (40)	6,9 (14.4)	— (15.1)			
	14,0 (50)	10,8 (24.0)	10,8 (24.0)	10,8 (24.0)	10,8 (24.0)		14,0 (50)	6,8 (12.9)	6,8 (13.6)	— (14.5)	— (15.1)	
	18,0 (60)	9,5 (20.7)	10,6 (23.2)	10,8 (24.0)	10,8 (24.0)	8,4 (18.5)	18,0 (60)	5,9 (10.9)	6,2 (11.6)	6,6 (12.5)	6,8 (13.2)	— (13.8)
	24,0 (80)	7,2 (15.6)	7,9 (17.0)	7,5 (16.3)	7,3 (15.7)	7,0 (15.1)	24,0 (80)	5,0 (—)	5,3 (10.3)	5,7 (11.1)	6,0 (11.6)	6,3 (11.0)
	30,0 (100)	5,8 (12.6)	5,7 (12.4)	5,4 (11.7)	5,1 (11.1)	4,8 (10.4)	30,0 (100)		4,7 (—)	5,0 (8.9)	5,3 (8.4)	5,1 (7.8)
	36,0 (120)		4,4 (9.4)	4,0 (8.7)	3,7 (8.0)	3,4 (7.3)	36,0 (120)			4,1 (—)	3,9 (6.2)	3,6 (5.5)
	42,0 (140)			3,1 (6.6)	2,8 (5.9)	2,4 (5.0)	42,0 (140)				2,9 (—)	2,6 (4.4)
	44,0 (150)			2,7 (5.3)	2,5 (5.0)	2,1 (4.1)	44,0 (150)					2,3 (—)
48,0 (160)				1,9 (4.0)	1,5 (3.2)	48,0 (160)					1,8 (—)	
52,0 (170)				1,4 (3.1)		52,0 (170)						

For complete chart, refer to [www.cranellibrary.com](http://www.cranellibrary.com).

Meets ASME B30.5 Requirements - Capacities do not exceed 75% of static tipping load.  
NOTICE: This capacity chart is for reference only and must not be used for lifting purposes.

# Fixed jib load charts

## Model 11000-1 liftcrane jib capacities No. 11000-1 fixed jib on main boom

28 800 kg (63,500 lb) upper counterweight, 7 300 kg (16,100 lb) carbody counterweight crawler extended  
360° Rating kg (lb) x 1 000

		10° offset					30° offset				
		24,4 (80)	30,5 (100)	39,6 (130)	48,8 (160)	57,9 (190)	24,4 (80)	30,5 (100)	39,6 (130)	48,8 (160)	57,9 (190)
jib 15,2 m (50 ft)	Radius										
	10,0 (30)										
	12,0 (40)	9,0 (20.0)	9,0 (20.0)								
	14,0 (50)	9,0 (20.0)	9,0 (20.0)	9,0 (20.0)							
	18,0 (60)	7,8 (17.0)	8,6 (18.9)	9,0 (20.0)	9,0 (20.0)	8,1 (18.4)	4,8 (10.4)	5,0 (10.9)	5,2 (11.4)		
	24,0 (80)	5,9 (12.8)	6,6 (14.4)	7,6 (16.5)	7,4 (15.9)	7,1 (15.3)	4,0 (8.7)	4,2 (9.2)	4,5 (9.8)	4,7 (10.3)	4,9 (10.7)
	30,0 (100)	4,7 (10.3)	5,3 (11.6)	5,5 (11.8)	5,2 (11.2)	4,9 (10.5)	3,4 (7.6)	3,7 (8.0)	3,9 (8.7)	4,2 (9.2)	4,4 (9.6)
	36,0 (120)	4,1 (—)	4,4 (9.5)	4,1 (8.8)	3,8 (8.2)	3,5 (7.5)			3,5 (7.6)	3,8 (8.3)	3,8 (8.1)
	42,0 (140)		3,5 (—)	3,1 (6.7)	2,8 (6.1)	2,4 (5.2)				3,0 (6.4)	2,7 (5.7)
	44,0 (150)			2,9 (5.8)	2,5 (5.2)	2,1 (4.2)				2,7 (5.5)	2,4 (4.7)
48,0 (160)			2,2 (4.6)	2,0 (4.3)	1,6 (—)					1,8 (3.8)	
52,0 (170)				1,5 (3.4)							
jib 18,3 m (60 ft)	Radius										
	10,0 (30)										
	12,0 (40)	8,1 (18.0)									
	14,0 (50)	8,1 (17.8)	8,1 (18.0)	— (18.0)							
	18,0 (60)	6,8 (14.8)	7,5 (16.3)	8,1 (18.0)	8,1 (18.0)	8,1 (18.0)	4,0 (8.9)				
	24,0 (80)	5,1 (11.1)	5,6 (12.3)	6,4 (14.1)	7,2 (15.6)	7,2 (15.4)	3,3 (7.3)	3,5 (7.7)	3,7 (8.1)	3,9 (8.5)	3,9 (8.7)
	30,0 (100)	4,0 (8.8)	4,5 (9.9)	5,2 (11.4)	5,2 (11.3)	4,9 (10.7)	2,8 (6.2)	3,0 (6.6)	3,2 (7.1)	3,4 (7.5)	3,5 (7.8)
	36,0 (120)	3,4 (7.3)	3,8 (8.2)	4,1 (8.9)	3,8 (8.3)	3,5 (7.5)		2,7 (5.9)	2,9 (6.3)	3,1 (6.7)	3,2 (7.0)
	42,0 (140)		3,2 (7.1)	3,1 (6.8)	2,9 (6.1)	2,4 (5.2)			2,6 (5.8)	2,8 (6.2)	2,7 (5.9)
	44,0 (150)		3,1 (—)	2,9 (6.0)	2,6 (5.3)	2,1 (4.3)				2,7 (5.7)	2,4 (4.9)
48,0 (160)			2,4 (5.0)	2,1 (4.4)	1,6 (3.4)				2,3 (4.9)	1,9 (4.0)	
52,0 (170)			— (4.0)	1,6 (3.6)						1,4 (3.2)	

For complete chart, refer to [www.cranelibrary.com](http://www.cranelibrary.com).

Meets ASME B30.5 Requirements - Capacities do not exceed 75% of static tipping load.  
NOTICE: This capacity chart is for reference only and must not be used for lifting purposes.

# Clamshell

## Boom:

Welded lattice construction using tubular, high-tensile steel chords with pin connections between sections.

Basic boom length: 12.2 m (40 ft)

Max. boom length: 30.5 m (100 ft)

Limit one clamshell bucket weight: 2 100 kg (4,600 lb)

## Maximum component chart

Boom length m (ft)	Boom arrangement
12.2 (40)	Base-Tip
15.2 (50)	Base-A-Tip
18.3 (60)	Base-A-A-Tip, Base-B-Tip
21.3 (70)	Base-A-B-Tip
24.4 (80)	Base-A-A-B-Tip, Base-B-B-Tip
27.4 (90)	Base-A-C-Tip
30.5 (100)	Base-A-A-C-Tip

Base = 6.10 m (20 ft)

Insert: A = 3.05 m (10 ft)

B = 6.10 m (20 ft)

C = 12.2 m (40 ft)

Tip = 6.10 m (20 ft)

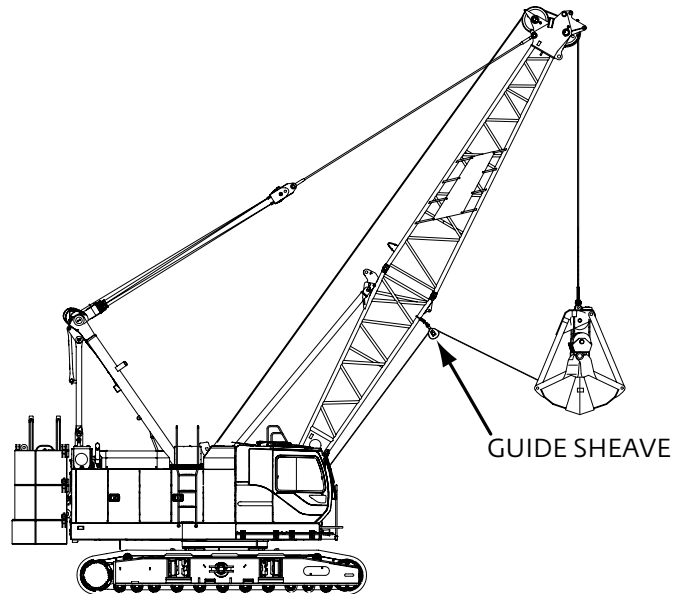

1. Figures represent maximum allowable capacity, and assume level ground and ideal working conditions.
2. Capacities are calculated at 66% of the minimum tipping loads.
3. Capacities are maximum recommended by PCSA Standard #4. Allowances must be made by the user for such unfavorable conditions as a soft or uneven supporting surface, rapid cycle operations, or bucket suction.
4. The combined weight of the bucket and load must not exceed these capacities.
5. Boom length for clamshell operation should not exceed 30.5 m (100 ft).

## Clamshell Capacities

19,8 t (13.3 USt) counterweight  
(three upper counterweights, crawlers extended)

kg (lb) x1 000

Boom m (ft)	12,2 (40)	15,2 (50)	18,3 (60)	21,3 (70)	24,4 (80)	27,4 (90)	30,5 (100)
Radius							
6,7 (22)	9,9* (22.0)						
7,9 (26)	9,9* (22.0)	9,9* (22.0)					
9,1 (30)	9,9* (22.0)	9,9* (22.0)	9,9* (22.0)				
10,4 (34)	9,8* (21.4)	9,8* (21.4)	9,8* (21.4)	9,7* (21.4)			
12,8 (42)		8,3* (17.3)	8,3* (17.3)	8,3* (17.3)	8,3* (17.3)	7,8* (17.3)	
15,2 (50)			6,2* (14.6)	6,2* (14.6)	6,2* (14.6)	6,2* (14.6)	6,2* (14.6)
17,7 (58)			5,6* (12.5)	5,5* (12.5)	5,5* (12.5)	5,7* (12.5)	5,5* (12.5)
20,1 (66)				5,0* (11.0)	5,0* (11.0)	5,0* (11.0)	5,0* (11.0)
22,6 (74)					4,3* (9.8)	4,3* (9.7)	4,2* (9.4)
25,0 (82)						3,5* (8.3)	3,7* (8.1)
26,8 (88)							3,3* (7.2)
28,7 (94)							2,9* (6.6)

Ratings shown by \* are determined by the strength of the boom or other structural components.

# Manitowoc Crane Care

**Crane Care** is Manitowoc's comprehensive service and support program. It includes classroom and on-site training, prompt parts availability, expert field service, technical support and documentation.

That's commitment you won't find anywhere else.

That's Crane Care.

## Service training

Manitowoc specialists work with you in our training centers and in the field to make sure you know how to get maximum performance, reliability and life from your cranes.

Manitowoc Cranes Technical Training Centers provide valuable multi-level training, which is available for all models and attachments, in the following format:

- **Intro to Canbus and Canbus 1, 2, 3**
- **Intro to EPIC and EPIC 1, 2, 3**
- **Small Crawler 1**
- **Canbus 1 and 2 assembly, operation and maintenance**
- **EPIC 1 and 2 assembly, operation and maintenance**

Refer to [www.manitowoc.com](http://www.manitowoc.com) for course descriptions.

## Parts availability

Genuine Manitowoc replacement parts are accessible through your distributor 24 hours a day, 7 days a week, 365 days a year.

### Service interval kits

**200 hour kit**

**1,000 hour kit**

**2,000 hour kit**

**Hydraulic test kit**

**U.S. standard tools kit**

## Field service

Factory-trained service experts are always ready to help maintain your crane's peak performance.

For a worldwide listing of dealer locations, please consult our website at: [www.manitowoc.com](http://www.manitowoc.com)

## Technical support

Manitowoc's dealer network and factory personnel are available 24 hours a day, 7 days a week, 365 days a year to answer your technical questions and more, with the help of computerized programs that simplify crane selection, lift planning, and ground-bearing calculations.

For a worldwide listing of dealer locations, please consult our website at: [www.manitowoc.com](http://www.manitowoc.com)

## Technical documentation

Manitowoc has the industry's most extensive documentation; available in major languages and formats that include print, videotape, and DVD/CD.

Additional copies available through your Authorized Manitowoc Distributor.

- Crane operator's manual
- Crane parts manual
- Crane capacity manual
- Crane vendor manual
- Crane service manual
- Luffing jib operator's/parts manual
- Capacity chart manual - attachments

Available from your Authorized Manitowoc Cranes Distributor, these videos are available in NTSC, PAL, SECAM, and DVD formats.

- Your Capacity Chart Video
- Respect the Limits Video
- Crane Safety Video
- Boom Inspection/Repair Video

## Crane Care Package

Manitowoc has assembled all of the available literature, CD's and videos listed above plus several Manitowoc premiums into one complete Crane Care Package, which is supplied to the owner of each new crane.



## Manitowoc Cranes

### Regional headquarters

#### Americas

**Manitowoc, Wisconsin, USA**

Tel: +1 920 684 6621

Fax: +1 920 683 6277

**Shady Grove, Pennsylvania, USA**

Tel: +1 717 597 8121

Fax: +1 717 597 4062

#### Europe, Middle East, Africa

**Ecully, France**

Tel: +33 (0)4 72 18 20 20

Fax: +33 (0)4 72 18 20 00

#### China

**Shanghai, China**

Tel: +86 21 6457 0066

Fax: +86 21 6457 4955

#### Greater Asia-Pacific

**Singapore**

Tel: +65 6264 1188

Fax: +65 6862 4040

### Regional offices

#### Americas

**Brazil**

Alphaville

**Mexico**

Monterrey

**Chile**

Santiago

#### Europe, Middle East,

**Africa**

**France**

Baudemont

Cergy

Decines

**Germany**

Langenfeld

**Italy**

Lainate

**Netherlands**

Breda

**Poland**

Warsaw

**Portugal**

Baltar

**Russia**

Moscow

**South Africa**

Johannesburg

**U.A.E.**

Dubai

**U.K.**

Buckingham

#### China

Beijing

Chengdu

Guangzhou

Xian

#### Greater Asia-Pacific

**Australia**

Brisbane

Melbourne

Sydney

**India**

Chennai

Delhi

Hyderabad

Pune

**Korea**

Seoul

**Philippines**

Makati City

**Singapore**

### Factories

**Brazil**

Passo Fundo

**China**

TaiAn

Zhangjiagang

**France**

Charlieu

Moulins

**Germany**

Wilhelmshaven

**India**

Pune

**Italy**

Niella Tanaro

**Portugal**

Baltar

Fânzeres

**Slovakia**

Saris

**USA**

Manitowoc

Port Washington

Shady Grove

This document is non-contractual. Constant improvement and engineering progress make it necessary that we reserve the right to make specification, equipment, and price changes without notice. Illustrations shown may include optional equipment and accessories and may not include all standard equipment.